

ASSEMBLY INSTRUCTIONS

PHOENIX CHANGING TOPPER

Model #10665

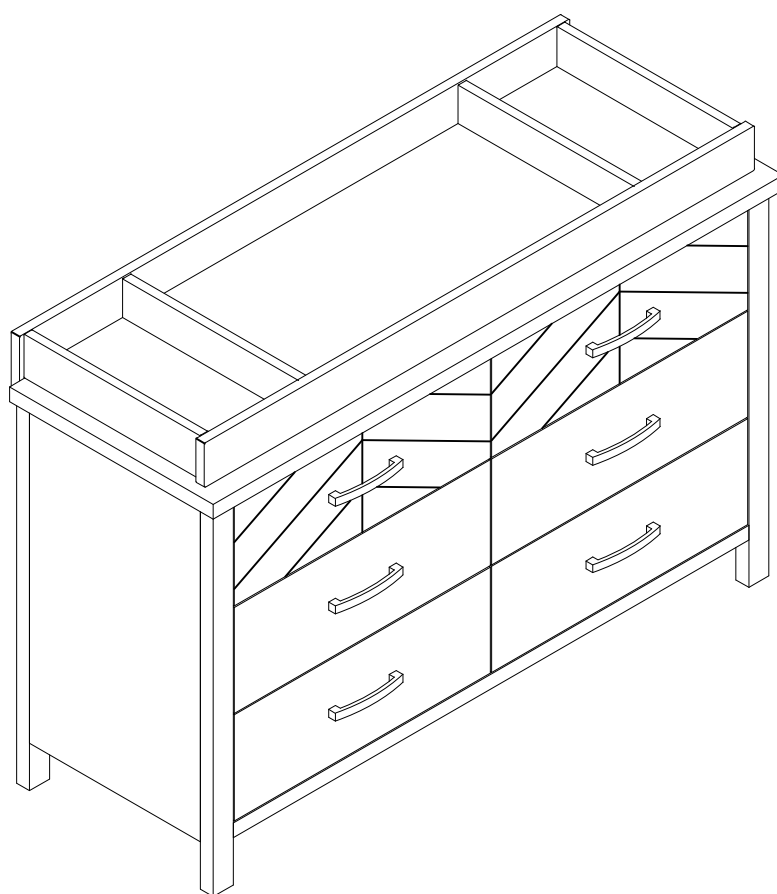

Thank you for your purchase!

Remove all parts and hardware from the box and lay on a carpeted or scratch -free work surface.
Do not dispose of any contents until assembly is completed.

TOOLS REQUIRED:

SCREW DRIVER (Not Included)

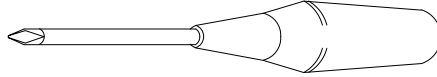

PARTS ENCLOSED IN CARTON

A. Changing Topper (1 pc)

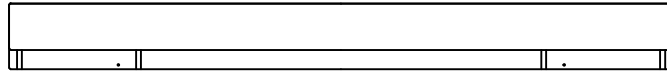

HARDWARE

(B) Screw 2" (50 mm) (2 pcs)

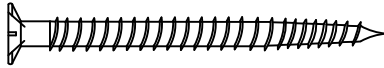

Do not fully tighten all Screws until all parts are in place.

ASSEMBLY OF CHANGING TOPPER

THIS STEP REQUIRES :

(B) Screw 2" (50 mm) (2 pcs)

SCREW DRIVER (Not Included)

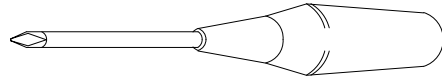
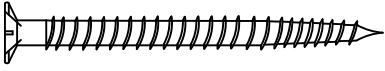

STEP 1:

- Place the changing topper on top of the dresser.
- The holes in back side should be below Dresser top surface. (see diagram)

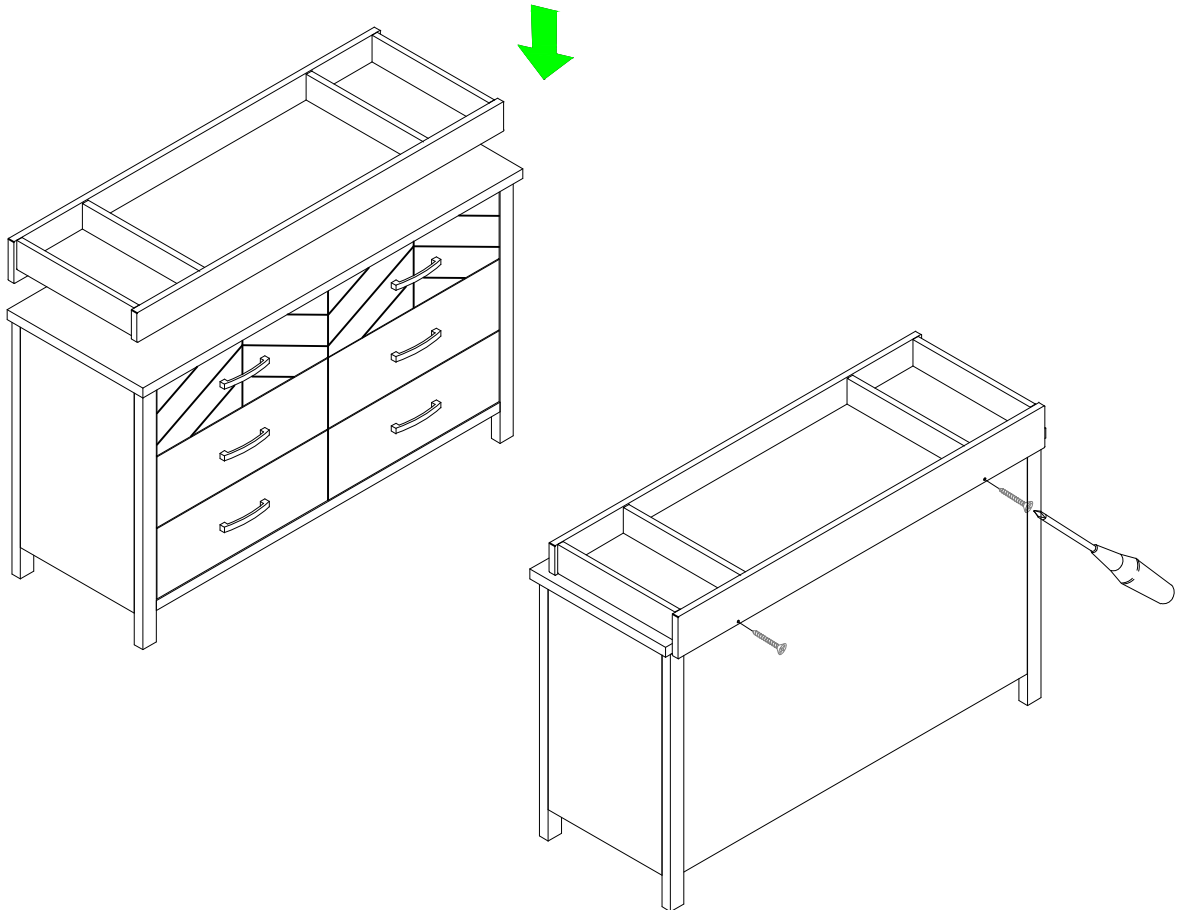

STEP 2:

Insert the screws into the back of the changing topper and dresser, tighten with Screw driver. Check to see that the changing topper is secure.



CAUTION: ANY PAD USED IN THIS CHANGING TOPPER MUST BE AT LEAST 16 INCHES BY 32 INCHES (41CM X 81CM) WITH A THICKNESS NOT EXCEEDING 1 INCH (2.54 CM).



WARNING

FOR CHANGING TOPPER USE

- READ ALL INSTRUCTIONS BEFORE ASSEMBLING CHANGING TOPPER.

KEEP INSTRUCTIONS FOR FUTURE USE.

- FAILURE TO FOLLOW THESE WARNINGS AND THE ASSEMBLY INSTRUCTIONS COULD RESULT IN SERIOUS INJURY OR DEATH.
- **CAUTION:** THE PAD INTENDED FOR USE ON THE CHANGING TOPPER SHALL HAVE MINIMUM DIMENSIONS OF 16 INCHES BY 32 INCHES (41 CM X 81 CM) WITH A THICKNESS NOT EXCEEDING 1 INCH (2.54 CM)
- THE MAXIMUM WEIGHT SHALL NOT BE GREATER THAN 30 LB (13.6 KG).
- **DO NOT** USE CHANGING TOPPER IF DAMAGED OR BROKEN.
- PLEASE CLEAN THE CHANGING TOPPER WITH A DRY CLOTH AND USE MILD WOOD POLISH IF REQUIRED.

FALL HAZARD: CHILDREN HAVE SUFFERED SERIOUS INJURIES AFTER FALLING FROM CHANGING TABLES. FALLS CAN HAPPEN QUICKLY.

- **STAY** IN ARM'S REACH OF YOUR CHILD.
- **ALWAYS** SECURE THIS UNIT TO THE SUPPORT SURFACE BY ATTACHING IT USING THE SCREWS PROVIDED. SEE INSTRUCTIONS.
- THE SURFACE USED SHOULD BE LEVEL, STABLE AND STRUCTURALLY SOUND WITH MINIMUM SURFACE DIMENSIONS OF 45.25.INCHES (114.93 CM) BY 17.25 INCHES (43.81 CM)