

ASSEMBLY INSTRUCTIONS
for Full Bed Conversion Kit
RHINEBECK 4 IN 1 CONVERTIBLE CRIB
Model #11588

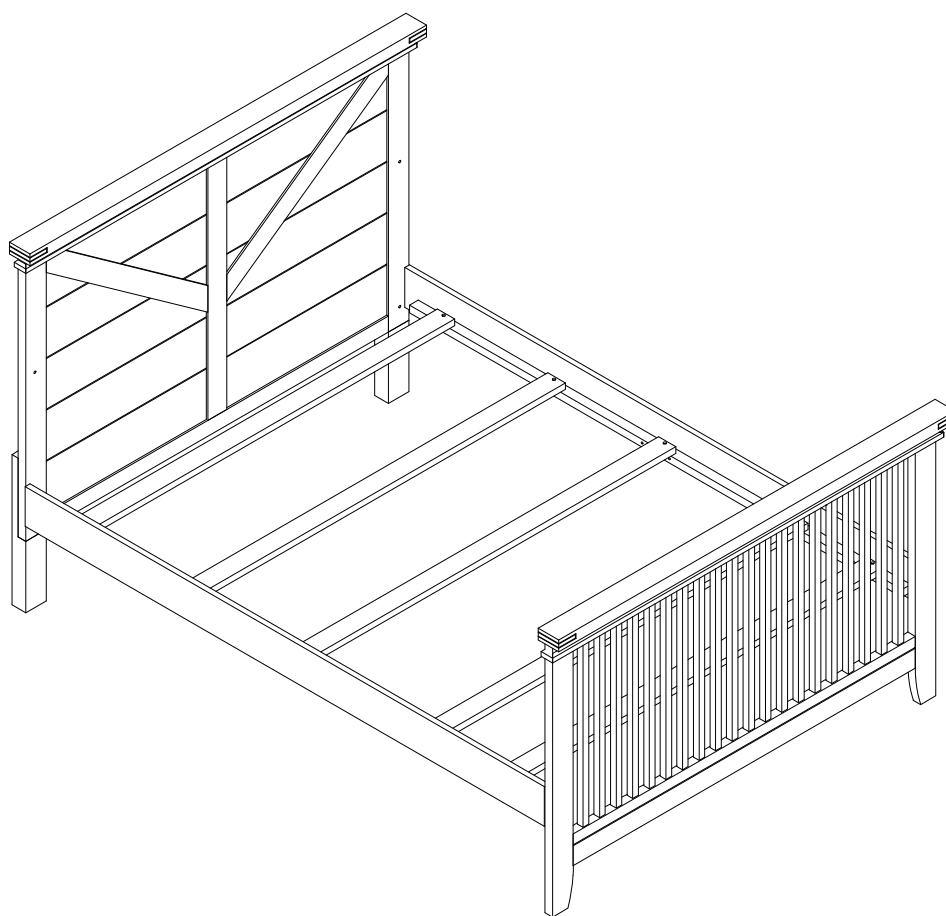

"RECOMMENDATION: We recommend the use of a Bunkie Board or box spring under a mattress for this conversion kit."

Thank you for your purchase!

Remove all parts and hardware from the box and lay on a carpeted or scratch -free work surface.

Do not dispose of any contents until assembly is completed.

Familiarize yourself with all exhibits and diagrams to facilitate the assembly of your crib.

TOOLS REQUIRED:

ALLEN KEY (Included)



SCREW DRIVER (Not Included)

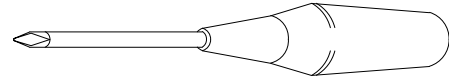

PARTS ENCLOSED IN CARTON

A. Rail (2 pcs)

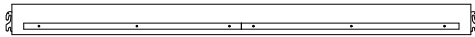

B. Slat (5 pcs)

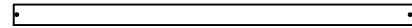

HARDWARE

(C) Allen Bolt 1"(25 mm) (2 pcs)

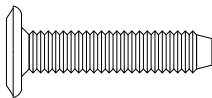

(D) Screw 1-1/4"(30 mm) (10 pcs)

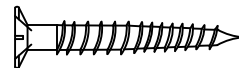

(E) Nut 3/4" (20mm) (2 pcs)

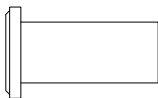

(F) Allen key (2 pcs) (length may vary)



Do not fully tighten all bolts until all parts are in place.
(please add an extra 1/2 revolution to the bolts when using spring washer after tightening)

STEP 1 " ASSEMBLY OF HEADBOARD AND FOOTBOARD"

THIS STEP REQUIRES :

- Headboard (1 pc)
- Footboard (1 pc)
- A. Rail (2 pcs)

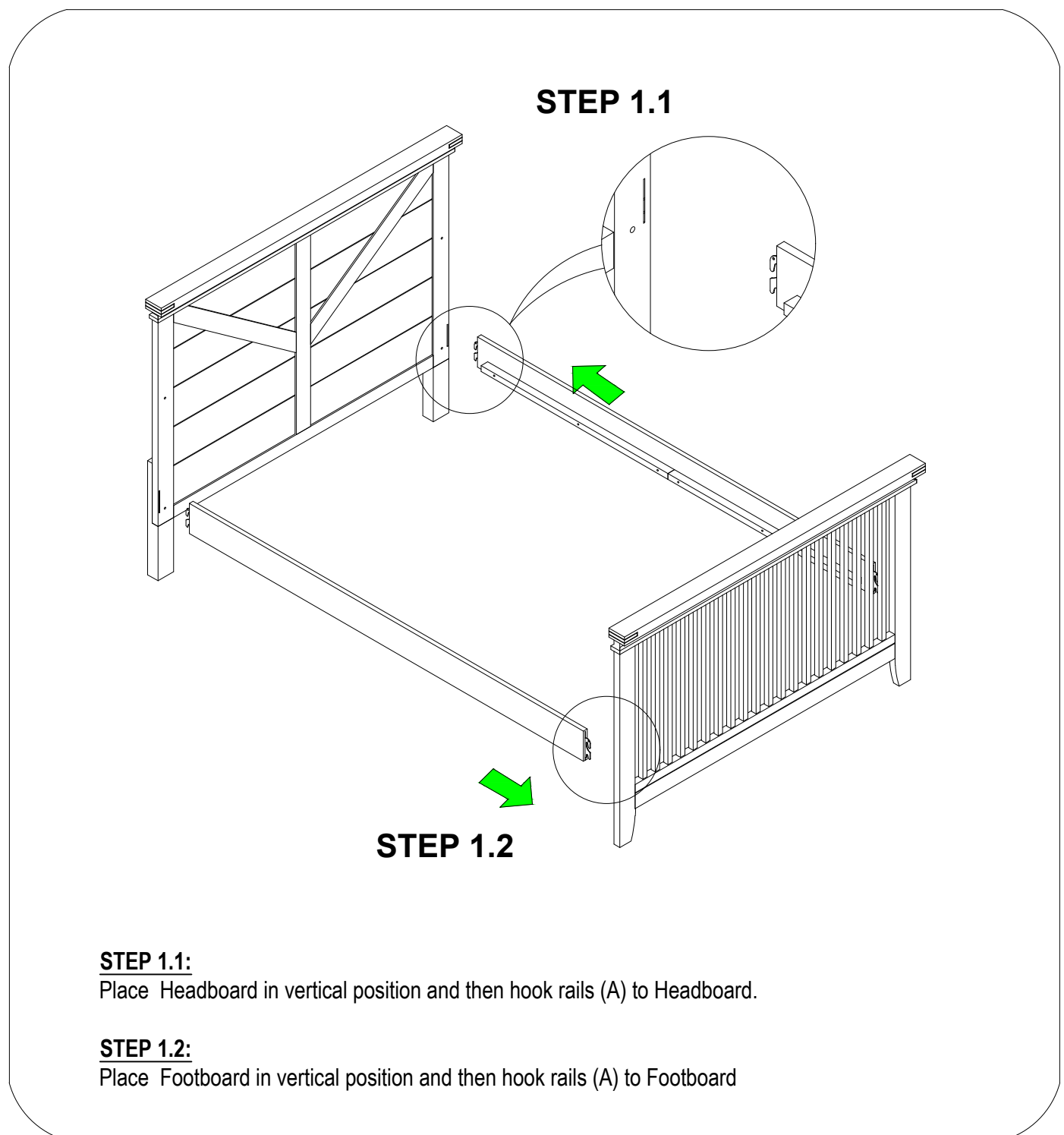

STEP 2 " ASSEMBLY OF SLATS"

THIS STEP REQUIRES :

B. Slat (5 pcs)

F. Allen key (2 pcs)

SCREW DRIVER (Not Included)

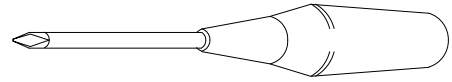
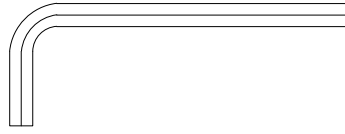

C. Allen Bolt 1"(25 mm) (2 pcs)

D. Screw 1 1/4"(30 mm) (10 pcs)

E. Nut 3/4" (20mm) (2 pcs)

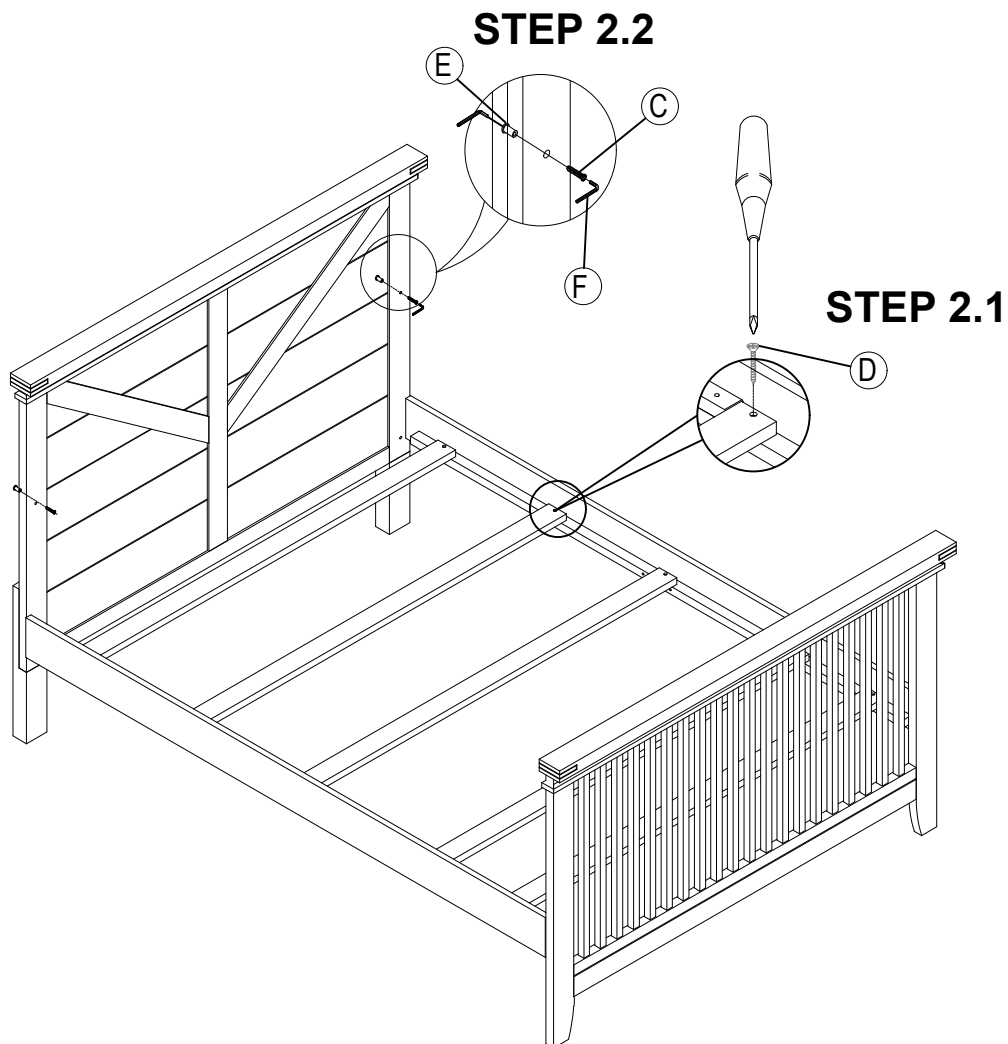
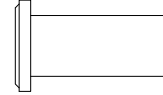
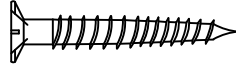
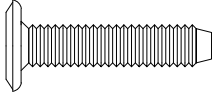

STEP 2.1:

- After attaching Rails (A) to headboard and footboard, place Slat (B) on the support strip of Rail (A), fasten both ends of Slat (B) with screw (D).
- Tighten all Screws with Screw Driver (not included).

STEP 2.2:

- Insert Allen bolt 1" (25 mm) (C), through the top hole in the headboard from the inside and connect with nut 3/4" (20 mm) (E).
- Tighten all bolts and nuts with Allen key (F). Assembly complete. Thanks you!