

ASSEMBLY INSTRUCTIONS

PIERMONT CHIFFEROBE

Model # 14045



oxford[™]
BABY

Thank you for your purchase!

The product is ready for use after removing all packing material. If you want to move the shelves up or down follow these steps:

1. Before removing the shelves, unscrew and remove the screws, which are attached to the shelf pegs underneath the shelves, with a screw driver.
2. Determine the desired height for the shelves using the corresponding pre-drilled holes located on the inside of the cabinet.
3. Insert the shelf pegs into the pre-drilled holes until fully secure. Place the shelves onto the shelf pegs, making sure the shelf is stable. Reinsert and tighten the screws back into the shelves by inserting the screw through the pre-drilled hole of the shelf peg and into the shelf. See illustration.

TOOLS REQUIRED:
SCREW DRIVER (Not Included)

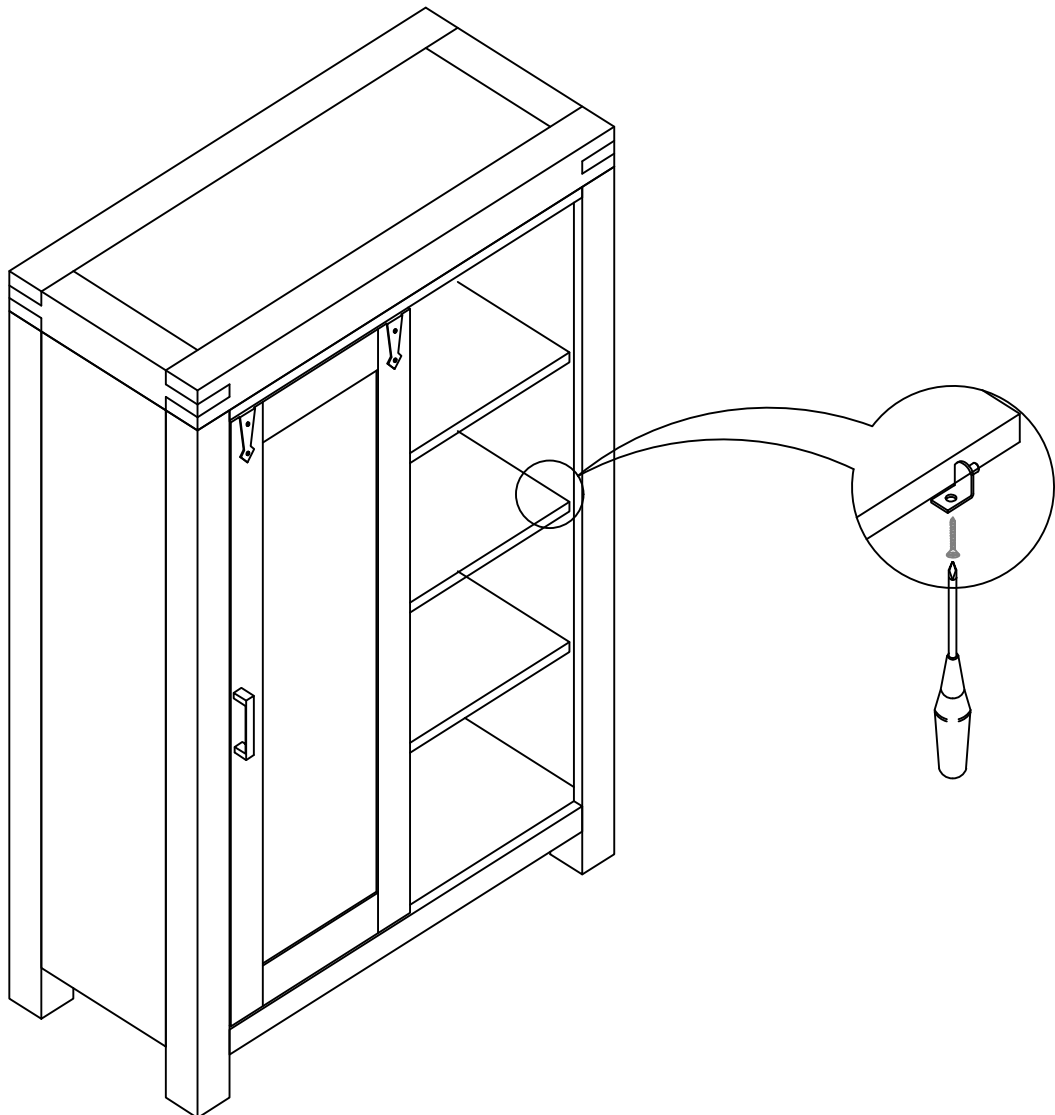
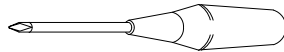

INSTALLATION INSTRUCTIONS :

This tip restraint must be attached to a wall stud using the 1 1/2" (38mm) screw enclosed.

1. Attach the bracket securely to the back top rail of the furniture using 3/4" (20mm) screw provided, through the smaller hole.
2. Locate the other bracket on the wall over a wall stud and 2 inches (50mm) below the mounting bracket secured to the back of your unit. Attach to the wall stud using the 1 1/2" (38mm) screw provided, through the smaller hole.
3. Place the furniture into position so both mounting brackets are vertically in line.
4. Lace the end of the restraint strap through the larger hole in each mounting bracket. Bring both ends together and slide the flat end through the locking end and draw it through until all slack is removed.
5. Confirm that the strap is securely laced and locked.

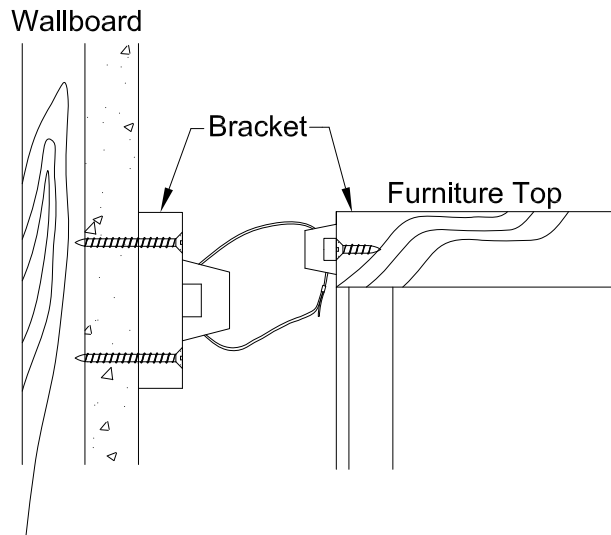

HARDWARE :

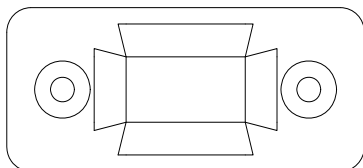

Safety Bracket - 2pcs

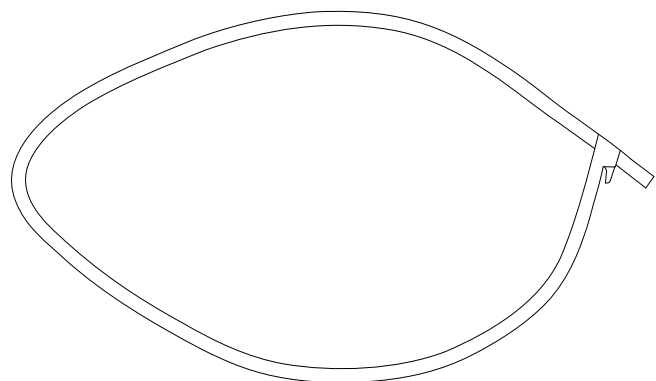

Restraint strap - 1pc

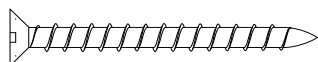

VIS#6X 1-1/2" (38mm) - 2pcs

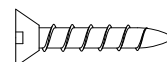

VIS#6x 3/4" (20mm) - 2pcs